

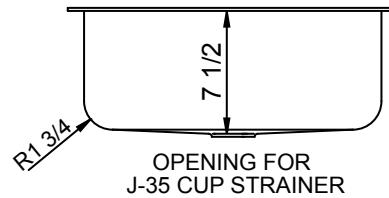

US-1620 - A - 18 GA.
UNDERMOUNT GROUP
 SINGLE COMPARTMENT

SUBMITTAL DATA

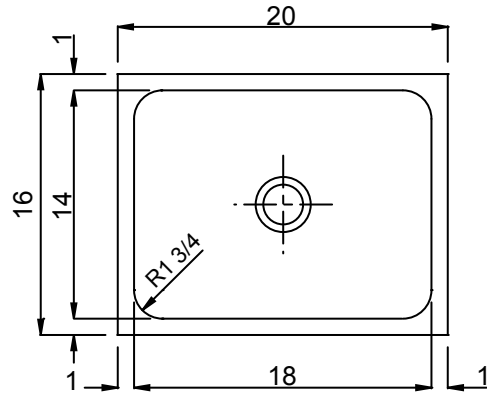

7.92
 Gallon
 Capacity*

***CAPACITY MATTERS**
 Max. I.D. sizing with straight-sided, non-tapered bowl configuration. Tight corner radius design.

SPECIFICATION

Seamless die-drawn construction of 18 gauge type 304 stainless steel. Interior and top surfaces polished to a non-porous Hand Blended Just Finish. Fully coated underside insulates for sound and reduces condensation. Straight sided compartment with 1-3/4" radius corners provides greater capacity. Drain punched for Just J-35-SSF drain. Certified to ASME/CSA A112.19.3/B45.4; UPC; IPC.



Sink certified to ASME A112.19.3/CSA B45.4; Uniform Plumbing Code (UPC); International Plumbing Code (IPC), by NSF International. Certified with/without overflow, less fittings.

TYPE 316 STAINLESS STEEL (Check if applicable)

APPROVED FOR MANUFACTURING

MODEL NO.: **US-1620-A** QTY: _____

JOB NAME: _____

TAG/ITEM: _____

CUSTOMER: _____

SIGNATURE: _____



JUST MFG. COMPANY CONTINUES TO MAKE QUALITY AND FUNCTIONALITY A MARK OF THE JUST PRODUCT LINE. WE RESERVE THE RIGHT TO CHANGE PRODUCT INFORMATION WITHOUT NOTICE. DIMENSIONS MAY CHANGE AND MAY BE SUBJECT TO CHANGE WITHOUT NOTICE. NO RESPONSIBILITY IS ASSUMED FOR USE OF SUPERCEDED OR VOIDED DATA. JUST MFG. CO. SINKS ARE MADE IN THE U.S.A. WHEN COMPARING OTHER BRAND PRODUCTS, BE SURE TO COMPARE USA QUALITY ALONG WITH FEATURES AND DIMENSIONS.

JUST MANUFACTURING COMPANY 9233 KING STREET FRANKLIN PARK ILLINOIS 60131-2111
 PH: 847-678-5150 . FAX: 847-678-6817 . E-MAIL: custserv@justmfg.com . www.justmfg.com