



UD-1848-A- 18 GA.

UNDERMOUNT GROUP DOUBLE COMPARTMENT

SUBMITTAL DATA



SPECIFICATION

Seamless die-drawn construction of 18 gauge type 304 stainless steel. Interior and top surfaces polished to a non-porous Hand Blended Just Finish. Fully coated underside insulates for sound and reduces condensation. Straight sided compartment with 1-3/4" radius corners provides greater capacity. Drain punched for Just J-35-SSF drain. Certified to ASME/CSA A112.19.3/B45.4; UPC; IPC.



Sink certified to ASME A112.19.3/CSA B45.4; Uniform Plumbing Code (UPC); International Plumbing Code (IPC), by NSF International. Certified with/without overflow, less fittings.

22.48
Gallon
Capacity*

*CAPACITY MATTERS

Max. I.D. sizing with straight-sided, non -tapered bowl configuration. Tight corner radius design.

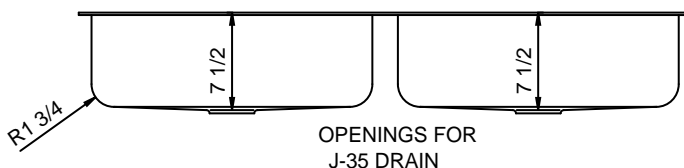
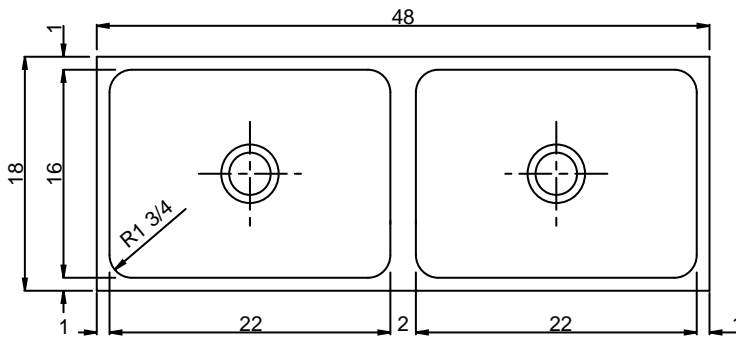

APPROVED FOR MANUFACTURING	
MODEL NO.:	UD-1848-A QTY: _____
JOB NAME:	_____
TAG/ITEM:	_____
CUSTOMER:	_____
SIGNATURE:	_____



JUST MFG. COMPANY CONTINUES TO MAKE QUALITY AND FUNCTIONALITY A MARK OF THE JUST PRODUCT LINE. WE RESERVE THE RIGHT TO CHANGE PRODUCT INFORMATION WITHOUT NOTICE. DIMENSIONS MAY CHANGE AND MAY BE SUBJECT TO CHANGE WITHOUT NOTICE. NO RESPONSIBILITY IS ASSUMED FOR USE OF SUPERCEDED OR VOIDED DATA. JUST MFG. CO. SINKS ARE MADE IN THE U.S.A. WHEN COMPARING OTHER BRAND PRODUCTS, BE SURE TO COMPARE USA QUALITY ALONG WITH FEATURES AND DIMENSIONS.

JUST MANUFACTURING COMPANY

9233 KING STREET . FRANKLIN PARK . ILLINOIS . 60131-2111

PH: 847-678-5150 . FAX: 847-678-6817 . E-MAIL: custserv@justmfg.com . www.justmfg.com