

JZRR-20295

ZERO RADIUS - UNDERMOUNT
DOUBLE COMPARTMENT

SUBMITTAL DATA

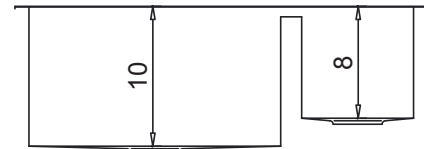
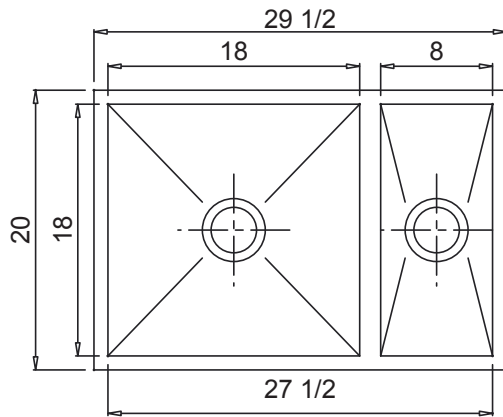
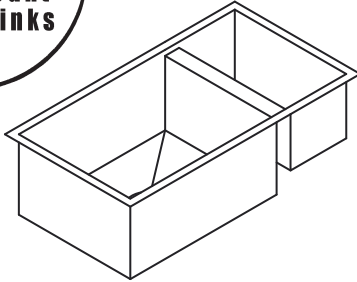

OPENING FOR J-35 DRAIN

SPECIFICATION

Seamless appearance, zero radius compartment, constructed of 16 gauge type 304, 18-8 stainless steel. Interior and top surfaces polished with a non-porous No. 4 finish. Fully coated underside insulates for sound, and reduces condensation. Embossed drain grooves, drain punch for Just J-35 drain.

17.48
Gallon
Capacity

Capacity Matters

Max ID sizing with straight sided bowl configuration (non tapered sides). Tight corner radius design.

APPROVED FOR MANUFACTURING

MODEL NO.: JZRR-20295 QTY: _____

JOB NAME: _____

TAG/ITEM: _____

CUSTOMER: _____

SIGNATURE: _____



JUST MFG. COMPANY CONTINUES TO MAKE QUALITY AND FUNCTIONALITY A MARK OF THE JUST PRODUCT LINE. TO DO SO REQUIRES THAT WE RESERVE THE RIGHT TO CHANGE PRODUCT INFORMATION WITHOUT NOTICE. DIMENSIONS MAY VARY AND ARE SUBJECT TO CHANGE WITHOUT NOTICE. NO RESPONSIBILITY IS ASSUMED FOR USE OF SUPERCEDED OR VOIDED DATA. FOR THE MOST CURRENT AND ACCURATE INFORMATION REGARDING THE COMPLETE LINE OF JUST SINKS, FAUCETS AND DRAINS, CLICK ON THE **SPEC LINE DRAWINGS** LINK ON OUR WEB SITE AT www.justmfg.com

JUST MANUFACTURING COMPANY

9233 KING STREET . FRANKLIN PARK . ILLINOIS . 60131-2111

PH: 847-678-5150 . FAX: 847-678-6817 . E-MAIL: custserv@justmfg.com . www.justmfg.com