



**HY-G1-TP**  
ENVIRO SERIES  
Single Portable Hand Wash Station

**Features:**

- Hands-free
- Child step
- ADA Compliant - side reach
- 2 hook up options: integral tank type or hose bib economy unit
- Indoor/Outdoor use
- Portable micro cart
- Optional 2nd set of tanks available

[CuVerro® antimicrobial copper-nickel surface option available]

**Specification:**

- Heavy-duty stainless steel construction of 16 and 18 gauge, type 304
- Hand-free sensor faucet and mixing valve
- Sensor activated soap dispenser
- Sensor activated towel dispenser
- Large capacity wash basin (ID: 16"W x 22"L x 5"D)
- Offset drain location rear corner to reduce aerosolization
- Recessing slide step for child height access
- 120 volt water heater 2 Imp. gallons
- 120 volt water pump
- Waste receptacle
- Heavy-duty handle for easy portability
- Removeable fresh water tanks
- Removeable waste water tanks
- Lockable access door
- Unit components are NSF, CSA, UL or equal approved

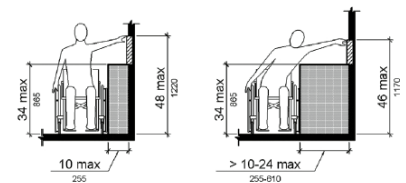
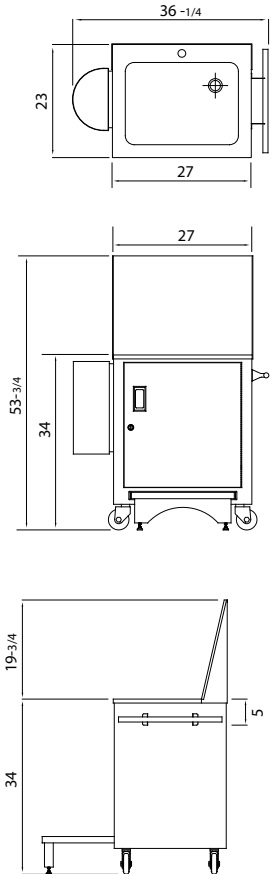

ADA: Unobstructed side reach

<https://www.ada.gov/reg2010/2010ADA-Standards/2010ADASTandards.htm#c3>

MODEL NO: **HY-G1-TP** QTY: \_\_\_\_\_

JOB NAME: \_\_\_\_\_

TAG / ITEM: \_\_\_\_\_

CUSTOMER: \_\_\_\_\_

SIGNATURE: \_\_\_\_\_

JUST MFG. COMPANY CONTINUES TO MAKE QUALITY AND FUNCTIONALITY A MARK OF THE JUST PRODUCT LINE. WE RESERVE THE RIGHT TO CHANGE PRODUCT INFORMATION WITHOUT NOTICE. DIMENSIONS MAY CHANGE AND MAY BE SUBJECT TO CHANGE WITHOUT NOTICE. NO RESPONSIBILITY IS ASSUMED FOR USE OF SUPERCEDED OR VOIDED DATA. JUST MFG. CO. SINKS ARE MADE IN THE U.S.A. WHEN COMPARING OTHER BRAND PRODUCTS, BE SURE TO COMPARE USA QUALITY ALONG WITH FEATURES AND DIMENSIONS.





HY-G1-TP  
ENVIRO SERIES  
FITTINGS PACKAGE

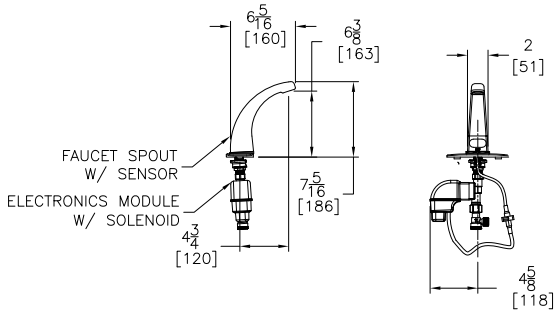

J-6913 Faucet:

Architectural/Engineering Specification:

AquaSense® faucets are ideal for high-use applications where durability and hands-free operation are necessary. ADA compliant, battery powered, polished chrome-plated cast brass sensor faucet with infrared proximity sensor for retrofit and new construction. Unit is furnished with a standard .5 GPM aerator, and mounting hardware. Just® Lead Free products (-N) is the line of durable, high quality brass faucets and fixtures that are designed and manufactured to comply with Section 1417 of the Safe Drinking Water Act (SDWA) which mandates the weighted average lead content of no more than 0.25% of the wetted surface. • Infrared convergence-type proximity sensor • 30 second time out feature • Chrome -plated Cast Brass Body • In-line filter • 4 "AA" batteries • Inlet for a 1/2" ball riser

Slimroll Electronic Towel Dispenser:

The sleek design and touchless dispensing system helps to minimize the spread of dirt and germs all while providing 25% more hand dries over folded towels. The most efficient system on the market, the ultra-compact Slimroll allows you to mount the dispenser close to sinks and in tight places and keeping it close to the water helps reduce drips and slips. Simply place a hand under the dispenser to receive a nominal 10 inches of towel, a second sheet will dispense at 10% reduced length when activated within a few seconds of the first dispense. The dispenser is made of high impact plastic with translucent sides and opaque black cover. • Quiet dispensing system & Quick load capability • Key or keyless entry option & 4 D-Cell batteries included • Includes lifetime warranty through Kimberly-Clark Professional • For use with corresponding Scott® Slimroll Paper Towel • Dispenses one 8" diameter, 580' hard roll towel • Dimensions: 12" x 12" x 7"

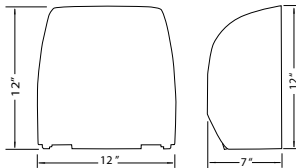

JSPD - 801 Soap Dispenser:

• Automatic operation via sensor activation • ADA compliant • Stainless steel body • Pre-measured dispensing volume (1-1.5ml) • Reservoir capacity 900ml-refillable (800 ml disposable supplied by others) • Sensor detection range adjustable (2.4 - 1.5 inches) (60 - 38 mm) • Sensing delay - 0.5 - 1 sec • Room temperature 41oF ~ 104oF (5o-40oC) • Viscosity range 1-3000 (cP)(mPas) • Self contained valve/nozzle (Peristaltic tube) • Battery operated (4) AA size alkaline (1.5V) • Battery life approx 1 year (25,000 activations).

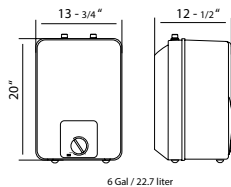
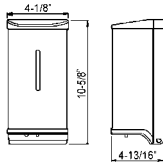

Electric Water Heater:

Just's® electric water heater is designed to take up as little room as possible and is the ideal choice for when installation space is limited to tight spaces such as under counters and in crawl spaces. With a 6-gallon (nominal) tank and 1 element delivering 1440 watts @ 120V, the EMT 6 is designed to fit into tight spaces. The Glass Lined Tank and Anode Rod help protect the tank from the corrosive effects of water, and is accompanied by a 6-year limited warranty.

Model 4100 Industrial Series "Quad" Pump:

Industrial Quad Pumps are designed for a wide range of applications and are constructed from a selection of materials suitable for handling a broad range of chemicals. The Quad series of diaphragm pumps are self-priming and can be run dry without harm. They are intended for intermittent duty cycles but can be run continuously for short periods of time. The higher the duty cycle the shorter the expected life of the pump. Typical pump uses are liquid transfer, spraying, cooling, circulation, filtration and dispensing.

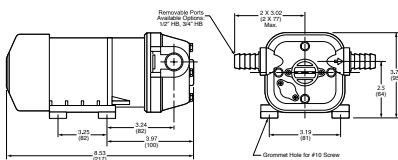

JTM-41 Thermostatic Mixing Valve:

Ideal for use where Lead Free® valves are required. The Just® Aqua-Gard® Thermostatic mixing valve is designed to be installed at the point of use under sinks and sensor faucets to assist in the prevention of scalding. The valves rapid response and precise temperature control meet the stringent standards of ASSE 1070 listed for fixtures, sinks, lavatories or bathtubs. The JTM-41 will mix hot and cold water from the distribution system to a final safer temperature outlet range of 95-115F (35-46C). The 3/8" compression fittings make this valve ideal for residential and commercial applications.

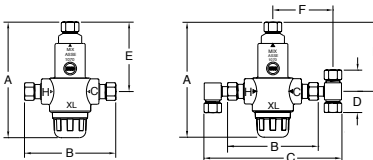

©2020 JUST MFG Co.

