

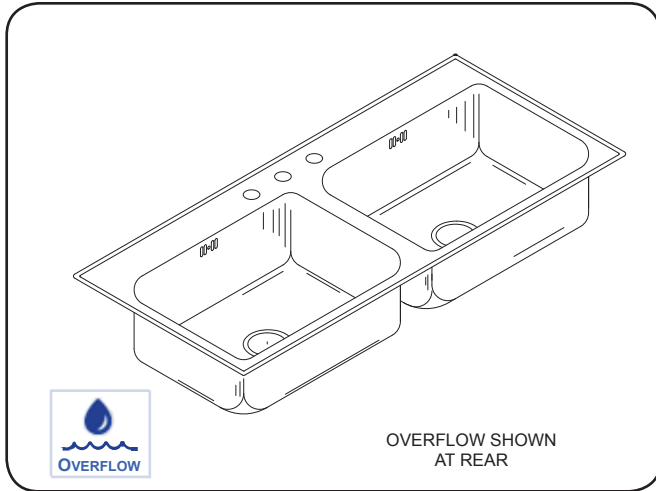

DLF-2249-A-GR

STYLIST GROUP DOUBLE COMPARTMENT with INTEGRA-FLOW 18 GAUGE

SUBMITTAL DATA



OVERFLOW SHOWN
AT REAR

17.54
Gallon
Capacity*

***CAPACITY MATTERS**

Max I.D. sizing with straight sided, non-tapered bowl configuration.

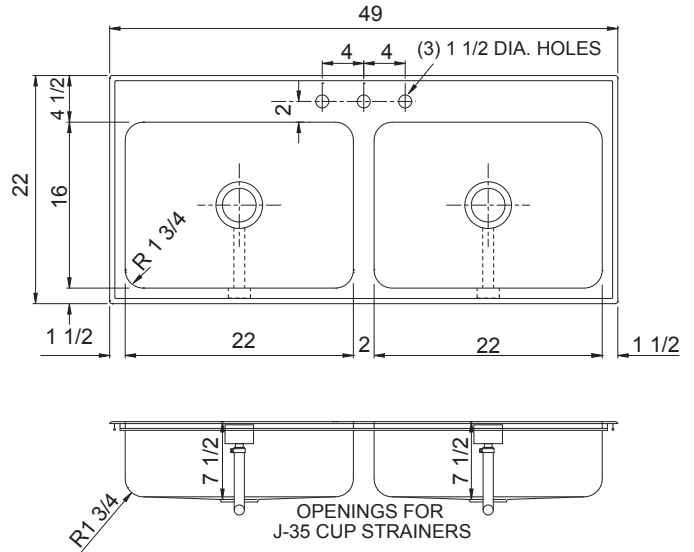

SPECIFICATION

Seamless die-drawn construction of 18 ga. type 304 stainless steel. Interior and top surfaces polished to a non-porous Hand Blended Just Finish. Fully coated underside insulates for sound and reduces condensation. Straight-sided compartment with 1-3/4" radius corners provides greater capacity. Self-rimming top mount with Grip-Rim Plus with stainless steel mounting channels. Integra-flow overflow system. Drain punched for Just J-35-SSF drain.

TYPE 316 Stainless Steel (ADD "-M" to model number)

CUTOUT DIMENSIONS		
Model Number	Front-to-Back	Left-to-Right
DLF-2249-A-GR	21-1/4	48-1/4

To Be Specified:

■ **Faucet Hole Punching:**

<input type="checkbox"/> (1) Hole Centered	
<input type="checkbox"/> (2) Holes on 4" centers	
<input type="checkbox"/> (3) Holes on 4" centers (illustrated)	
<input type="checkbox"/> Alternate Punching: Faucet Model: _____	Punching required: _____

OVERFLOW LOCATION MUST BE SPECIFIED:

<input type="checkbox"/> FRONT (SHOWN)	<input type="checkbox"/> REAR	<input type="checkbox"/> LEFT	<input type="checkbox"/> RIGHT
--	-------------------------------	-------------------------------	--------------------------------

APPROVED FOR MANUFACTURING

MODEL NO.: **DLF-2249-A-GR** QTY: _____

JOB NAME: _____

TAG/ITEM: _____

CUSTOMER: _____

SIGNATURE: _____



JUST MFG. COMPANY CONTINUES TO MAKE QUALITY AND FUNCTIONALITY A MARK OF THE JUST PRODUCT LINE. WE RESERVE THE RIGHT TO CHANGE PRODUCT INFORMATION WITHOUT NOTICE. DIMENSIONS MAY CHANGE AND MAY BE SUBJECT TO CHANGE WITHOUT NOTICE. NO RESPONSIBILITY IS ASSUMED FOR USE OF SUPERCEDED OR VOIDED DATA. JUST MFG. CO. SINKS ARE MADE IN THE U.S.A. WHEN COMPARING OTHER BRAND PRODUCTS, BE SURE TO COMPARE USA QUALITY ALONG WITH FEATURES AND DIMENSIONS.

JUST MANUFACTURING COMPANY 9233 KING STREET . FRANKLIN PARK . ILLINOIS . 60131-2111
 PH: 847-678-5150 . FAX: 847-678-6817 . E-MAIL: custserv@justmfg.com . www.justmfg.com