



**Cu SELF-RIMMING OVAL BOWL
with Grip-Rim PLUS**



ADA COMPLIANT

SPECIFICATIONS

- Sink touch surfaces - CuVerro® antimicrobial copper material - continuously reduces bacterial* contamination, achieving 99.9% reduction within 2 hours of exposure.
- CuVerro® antimicrobial copper-nickel alloy.
- Seamless construction 18 ga.
- Self-rimming with Grip-Rim PLUS® clips
- Interior and top surfaces polished to a non-porous Hand-Blended Just Finish.
- Fully coated underside insulates for sound, and reduces condensation.
- Drain punched for Just J-15-FS series drain.

JUST MFG. COMPANY CONTINUES TO MAKE QUALITY AND FUNCTIONALITY A MARK OF THE JUST PRODUCT LINE. TO DO SO REQUIRES THAT WE RESERVE THE RIGHT TO CHANGE PRODUCT INFORMATION WITHOUT NOTICE. DIMENSIONS MAY VARY AND ARE SUBJECT TO CHANGE WITHOUT NOTICE. NO RESPONSIBILITY IS ASSUMED FOR USE OF SUPERCEDED OR VOIDED DATA. FOR THE MOST CURRENT AND ACCURATE INFORMATION REGARDING THE COMPLETE LINE OF JUST SINKS, FAUCETS AND DRAINS, CLICK ON THE **SPEC LINE DRAWINGS** LINK ON OUR WEB SITE AT www.justmfg.com

APPROVED FOR MANUFACTURING

MODEL NO.: **Cu-LOLR-18521** QTY: _____

JOB NAME: _____

TAG/ITEM: _____

CUSTOMER: _____

SIGNATURE: _____

Cu-LOLR-18521

HEALTHCARE PRODUCT

Made with
CuVerro® Antimicrobial Copper-Nickel Alloy

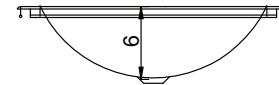
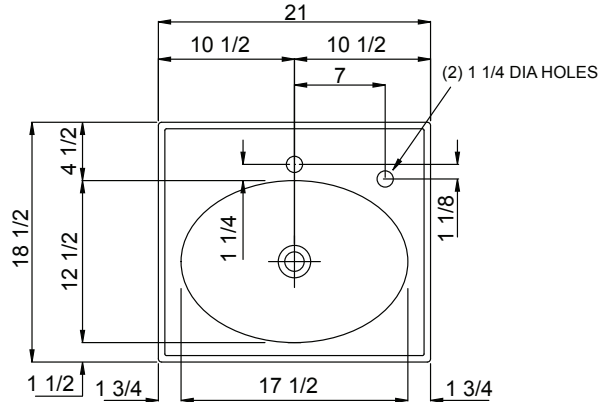

OPENING FOR
J-15-FS DRAIN



**Laboratory testing has shown that when cleaned regularly CuVerro® copper surfaces: kill more than 99.9% of bacteria* within 2 hours, and continue to kill 99% of bacteria even after repeated contamination. Testing demonstrates effective antibacterial activity against MRSA, Staphylococcus aureus, Enterobacter aerogenes, Pseudomonas aeruginosa, and E. coli O157:H7.*

CuVerro®, copper alloy surfaces have been shown to reduce microbial contamination, but does not necessarily prevent cross-contamination. The use of a copper alloy surface is a supplement to and not a substitute for standard infection control practices; users must follow all current infection control practices, including those practices related to cleaning and disinfection of environmental surfaces.

Copper alloy surfaces are for use only in non-food zone areas.

CuVerro® is a registered trademark of GBC Metals LLC, d/b/a Olin Brass. CuVerro® antimicrobial alloys are registered with the U.S. Environmental Protection Agency as antimicrobial under product registration #85353-5. Document approval #J-0001-1201.

Product Note: Copper surfaces are susceptible to staining and color variations (patina) over time. However, the antimicrobial properties - the primary benefit of this copper/nickel material - are not compromised as a result of the stains and potential discoloration. Proper application (use), care and maintenance is essential with copper/nickel alloys. Contact customer service for questions about the use, care and maintenance of copper/nickel sinks at custserv@justmfg.com or phone 847-678-5150.

JUST MANUFACTURING COMPANY

9233 KING STREET . FRANKLIN PARK . ILLINOIS . 60131-2111

PH: 847-678-5150 . FAX: 847-678-6817 . E-MAIL: custserv@justmfg.com . www.justmfg.com