



CRS-ADA-1925-A-GR-L - 18ga.



ACADEMIC GROUP - ADA COMPLIANT CLASSROOM SINK FAUCET LEDGE - LEFT / BUBBLER LEDGE- LEFT

SUBMITTAL DATA

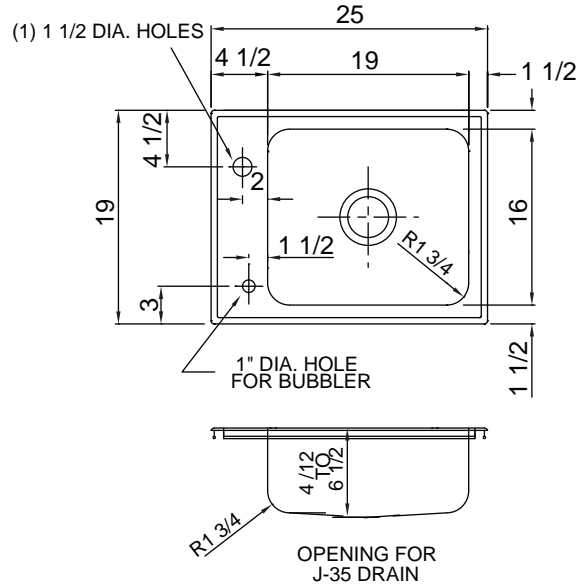

SPECIFICATION

Seamless die-drawn construction of Type-304, 18-8 stainless steel. Interior and top surfaces polished to a non-porous Hand-Blended Just Finish with highlighted bowl rim. Fully coated underside insulated for sound and reduces condensation. Stright-sided compartment with radius corners provides greater capacity. Self-rimming top mount Grip-Rim Plus with stainless steel mounting channels. Conforms to ASME/ANSI A112.19.3M. Certified conformance with ASME A112.19.3/CSA B45.4, Canadian Standards (CSA), Uniform Plumbing Code (UPC) and International Plumbing Code (IPC) and Americans with Disabilities Act (ADA)

8.29 **Capacity Matters**
Gallon Capacity* Max ID sizing with straight sided bowl configuration (non tapered sides). Tight corner radius design.
**Capacity is based on 6-1/2" Depths*

TYPE 316 STAINLESS STEEL(check if applicable)

CUTOUT DIMENSIONS		
Model Number	Front-to-Back	Left-to-Right
CRS-ADA-1925-A-GR-L	18-1/4	24-1/4

FAUCET PUNCHING - MUST BE SPECIFIED	
<input type="checkbox"/> (1) Hole (illustrated)	<input type="checkbox"/> (1) Hole - Left front (illustrated)
<input type="checkbox"/> (2) Holes on 4" centers	
<input type="checkbox"/> (3) Holes on 4" centers	
<input type="checkbox"/> Alternate Punching: Faucet Model:	Punching Required:
DEPTH - MUST BE SPECIFIED:	
<input type="checkbox"/> 4 1/2" DEEP	<input type="checkbox"/> 5" DEEP
<input type="checkbox"/> 5-1/2" DEEP	<input type="checkbox"/> 6" DEEP
<input type="checkbox"/> 6-1/2" DEEP	
DRAIN LOCATION - MUST BE SPECIFIED:	
<input type="checkbox"/> CENTER	<input type="checkbox"/> CENTER REAR
<input type="checkbox"/> LEFT REAR	<input type="checkbox"/> RIGHT REAR

APPROVED FOR MANUFACTURING

MODEL NO.: _____ QTY: _____

JOB NAME: _____

TAG/ITEM: _____

CUSTOMER: _____

SIGNATURE: _____



JUST MFG. COMPANY CONTINUES TO MAKE QUALITY AND FUNCTIONALITY A MARK OF THE JUST PRODUCT LINE. TO DO SO REQUIRES THAT WE RESERVE THE RIGHT TO CHANGE PRODUCT INFORMATION WITHOUT NOTICE. DIMENSIONS MAY VARY AND ARE SUBJECT TO CHANGE WITHOUT NOTICE. NO RESPONSIBILITY IS ASSUMED FOR USE OF SUPERCEDED OR VOIDED DATA. FOR THE MOST CURRENT AND ACCURATE INFORMATION REGARDING THE COMPLETE LINE OF JUST SINKS, FAUCETS AND DRAINS, CLICK ON THE **SPEC LINE DRAWINGS** LINK ON OUR WEB SITE AT www.justmfg.com

REVISED-6/2007