

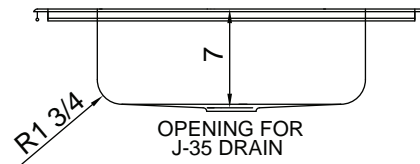

CRA-1928-B-GR

STYLIST GROUP CLASSROOM SINK

FAUCET LEDGE- LEFT / BUBBLER LEDGE- RIGHT

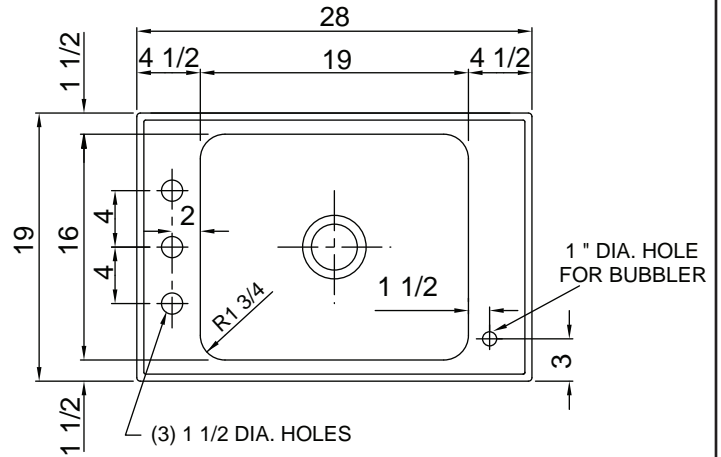

SPECIFICATION

Seamless die-drawn construction of Type 304, 18-8 stainless steel. Interior and top surfaces polished to a non-porous Hand-Blended Just Finish with highlighted bowl rim. Fully coated underside insulated for sound and reduces condensation. Straight-sided compartment with radius corners provides greater capacity. Self-rimming top mount Grip-Rim Plus with stainless steel mounting channels. Conforms to ASME/ANSI A112.19.3M. Certified conformance with ASME A 112.19.3/CSA B45.4, Canadian Standards (CSA), Uniform Plumbing Code (UPC) and International Plumbing Code (IPC). Drain punch 3-1/2" centered for Just J-35.

8.94
Gallon
Capacity

Capacity Matters

Max ID sizing with straight sided bowl configuration (non tapered sides). Tight corner radius design.

CUTOUT DIMENSIONS

Model Number	Front-to-Back	Left-to-Right
CRA-1928-B-GR	18-1/4	27-1/4

To Be Specified:

Faucet Hole Punching:	Bubbler Punching:
<input type="checkbox"/> (1) Hole Centered	<input type="checkbox"/> (1) Hole - Right front (illustrated)
<input type="checkbox"/> (2) Holes on 4" centers	
<input type="checkbox"/> (3) Holes on 4" centers (illustrated)	
<input type="checkbox"/> Alternate Punching: Faucet Model: _____	Punching required: _____

APPROVED FOR MANUFACTURING

MODEL NO.: _____ QTY: _____

JOB NAME: _____

TAG/ITEM: _____

CUSTOMER: _____

SIGNATURE: _____



JUST MFG. COMPANY CONTINUES TO MAKE QUALITY AND FUNCTIONALITY A MARK OF THE JUST PRODUCT LINE. TO DO SO REQUIRES THAT WE RESERVE THE RIGHT TO CHANGE PRODUCT INFORMATION WITHOUT NOTICE. DIMENSIONS MAY VARY AND ARE SUBJECT TO CHANGE WITHOUT NOTICE. NO RESPONSIBILITY IS ASSUMED FOR USE OF SUPERCEDED OR VOIDED DATA. FOR THE MOST CURRENT AND ACCURATE INFORMATION REGARDING THE COMPLETE LINE OF JUST SINKS, FAUCETS AND DRAINS, CLICK ON THE **SPEC LINE DRAWINGS** LINK ON OUR WEB SITE AT www.justmfg.com

JUST MANUFACTURING COMPANY

9233 KING STREET . FRANKLIN PARK . ILLINOIS . 60131-2111

PH: 847-678-5150 . FAX: 847-678-6817 . E-MAIL: custserv@justmfg.com . www.justmfg.com