

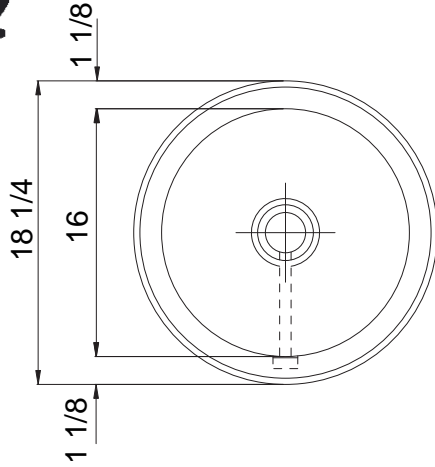

# CIF-ADA-16 - 18GA.

## LAVATORY GROUP

CIRCULAR LAVATORY  
FLAT RIM - WITH OVERFLOW



FRONT MOUNTED CONNECTED OVERFLOW

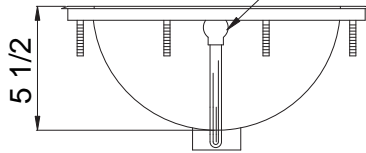

OPENING FOR STANDARD POP-UP DRAIN



CUTOUT DIMENSIONS	
Model Number	CIRCULAR
CIF-ADA-16	17-1/2 DIA.



**ADA COMPLIANT**

**2.0**  
Gallon Capacity

**Capacity Matters**  
Max ID sizing with straight sided bowl configuration (non tapered sides). Tight corner radius design.

### SPECIFICATION

Seamless die-drawn construction of Type 304, 18-8 stainless steel. Interior and top surfaces polished to a non-porous Hand-Blended Just Finish with highlighted bowl rim. Fully coated underside insulated for sound and reduces condensation. Straight-sided compartment with radius corners provides greater capacity. Self-rimming top mount Grip-Rim Plus with stainless steel mounting channels. Conforms to ASME/ANSI A112.19.3M. Certified conformance with ASME A112.19.3/CSA B45.4, Canadian Standards (CSA), Uniform Plumbing Code (UPC) and International Plumbing Code (IPC).



JUST MFG. COMPANY CONTINUES TO MAKE QUALITY AND FUNCTIONALITY A MARK OF THE JUST PRODUCT LINE. TO DO SO REQUIRES THAT WE RESERVE THE RIGHT TO CHANGE PRODUCT INFORMATION WITHOUT NOTICE. DIMENSIONS MAY VARY AND ARE SUBJECT TO CHANGE WITHOUT NOTICE. NO RESPONSIBILITY IS ASSUMED FOR USE OF SUPERCEDED OR VOIDED DATA. FOR THE MOST CURRENT AND ACCURATE INFORMATION REGARDING THE COMPLETE LINE OF JUST SINKS, FAUCETS AND DRAINS, CLICK ON THE **SPEC LINE DRAWINGS** LINK ON OUR WEB SITE AT [www.justmfg.com](http://www.justmfg.com)

Job Name \_\_\_\_\_

Customer \_\_\_\_\_

Architect/Engineer \_\_\_\_\_

APPROVED FOR MANUFACTURING

MODEL NO. \_\_\_\_\_ QTY. \_\_\_\_\_

COMPANY \_\_\_\_\_

TITLE \_\_\_\_\_ DATE \_\_\_\_\_

SIGNATURE \_\_\_\_\_

REVISED-8/2014

**SUBMITTAL DATA**